



Quick Start Guide

Eclipse 2.0 10" Touch Panel



CR-ECP-10-KNX-XXX

Package Contents

- Core Eclipse 2.0 10" Touch Panel
- Screws
- Metal Mounting Support
- Connectors

Core Bina Otomasyon Sistemleri Ltd. Şti.

Fatih Mahallesi Ege Caddesi No:42/5
Gaziemir - İzmir - Türkiye

www.core.com.tr



CONCEPT	DESCRIPTION	CONCEPT	DESCRIPTION
CPU	: 1.8 GHz Quad Core ARM Cortex- A55 CPU / Rockchip RK3566 Chipset	Sensors	: Temperature, Humidity, Proximity, Ambient Light
Memory	: 2GB	RS-485	: x
Hard Disk	: 8GB EMMC	RS-232	: x
Operating System	: Android 12	Dual Network Connectivity	: No
Power	: 12-30 VDC & POE	LAN	: 1
Screen Size	: 10,1"	Wi-Fi	: No
Resolution	: 1920px X 1200px	Microphone	: Microphone array
Speaker	: 2 x 4 Ohm - 2 Watts	Input	: 1 Digital Inputs
KNX Bus Connection	: KNX-TP	Operating System	: CoreOS 4.0
Thermostat Logic.	: Yes	Installation	: Surface Mounting with 2M Inwall Box
Output	: x		

Components



Safety Remarks



Rear View

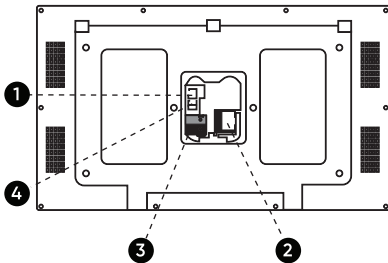

1. 12-30 VDC
2. ETH(POE)
3. KNX
4. Digital Input

Front View

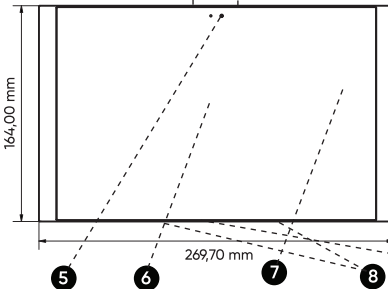

5. Proximity
6. LCD
7. Touch Panel
8. Speaker
9. Microphone
10. Temperature and Humidity Sensor

Side View
13,00 mm

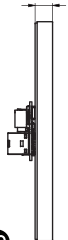

Warnings

• Installation, electrical connection, configuration and commissioning of the device can only be carried out by qualified personnel in compliance with the applicable technical standards and laws of the respective countries.

• The electrical connection of the device can only be carried out by qualified personnel. The incorrect installation may result in electric shock or fire. Before making the electrical connections, make sure the power supply has been turned off.

• Do not connect the main voltage (230V AC) to VDC input, digital input and KNX connector of the device.

• Opening the housing of the device causes the immediate end of warranty period.

• In case of tampering, the compliance with the essential requirements of the applicable

directives, for which the device has been certified, is no longer guaranteed.

• To clean use a dry cloth. It must be avoided the use of solvents or other aggressive substances.

• Contact with fluids to the plate and socket is to be avoided.

• The device can not be installed close to the heat sources such as radiators or household appliances or in position subjected to direct sunlight.

• The device has to be installed preferably on an internal wall at the height of 1,5m and at least 0,3m far from doors.

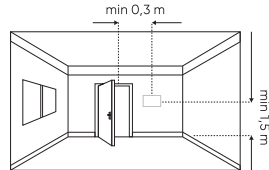

1. Mount the metal mounting support.
(Included in the box.)

⚠ Use screws included in the box (M3x15 mm)

⚠ Do not overtighten the screw

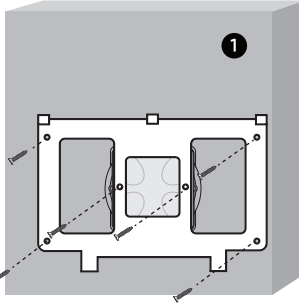

2. Connect ethernet cable, digital input (if used), KNX cable and DC power cable to the device. Check that polarities are correct.

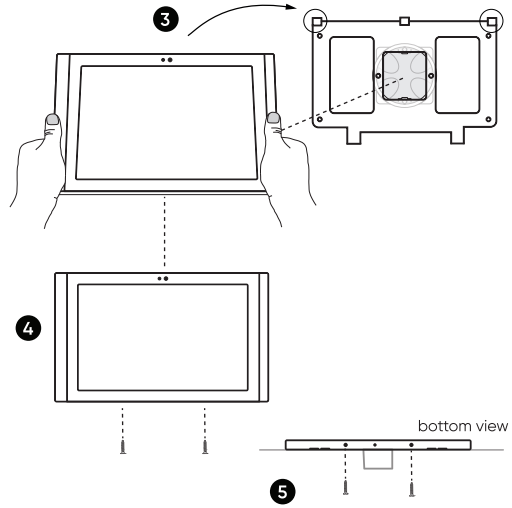
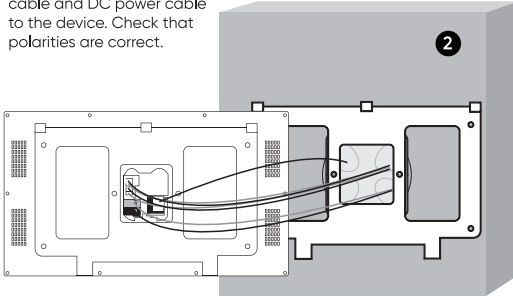

3. First connect the hooks on the upper side of the plate
4. Press and place the device with both hands simultaneously on the right and left side.
5. Screw the plate to the device from the bottom

- Eclipse 2.0 10" Touch Panel is configured via built-in web interface. Ethernet network interface is set to DHCP mode by default.

- Connect Eclipse 2.0 10" Touch Panel to a network that has DHCP server via home or building network.

- Go to settings in Eclipse 2.0 10" Touch Panel user interface and then get IP address of Touch Panel. If there is no DHCP server on network, set IP address of Touch Panel manually. For this check programming manual.

- Enter IP address to web-browser, then enter username and password

Default username: webAdmin

Default password: wa1234

- For support in further steps, check Programming Manual.

Core Bina Otomasyon Sistemleri Ltd. Şti.
Fatih Mahallesi Ege Caddesi No:42/5
Gazimir - İzmir - Türkiye

User
Manual

Programming
Manual

