

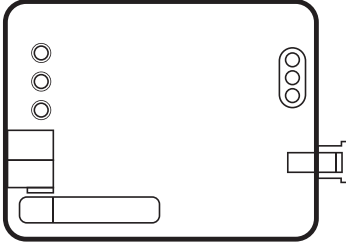

Quick Start Guide

KNX – LG VRF GATEWAY



CR-CG-LG-KNX-01

Package Contents

- Core LG VRF KNX Gateway
- Connection cable

Core Bina Otomasyon Sistemleri Ltd. Şti.

Fatih Mahallesi Ege Caddesi No:42/5
Gaziemir – Izmir – Türkiye

www.core.com.tr



Compatibility List Programming Manual



CONCEPT	DESCRIPTION
Type of Device:	Core LG VRF KNX Gateway
Power Consumption:	10mA Max.
Complementary Mode:	S-Mode, System-B
Dimensions:	68.50mm X 4900mm X 19.70mm
Response on AC Unit Faults / Disconnect:	LED2 Red Flashes (500ms On, 500ms Off)
Number of Inputs:	2 Digital Inputs
Input Switching Type:	Dry Voltage Contacts between Input and Common
Input Cable Cross-Section:	0.5-1mm2(IEC) / 26-16AWG(UL)
Connection Cable Length:	1m approx
Connection Cable Specification:	4x0.34mm(29AWG) with Screen for reduced interference
Connection @ AC Unit Equipment Side:	CN-REMO
Certification:	KNX Certified
Configuration:	Configuration with ETS

Components



Safety Remarks

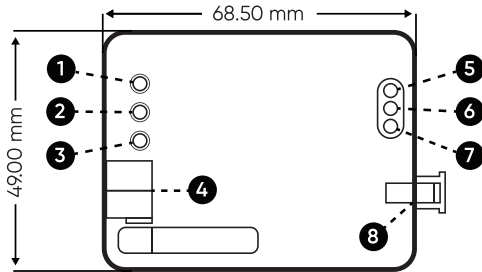

Front View

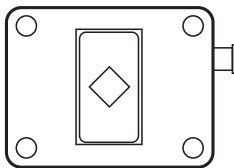

Rear View

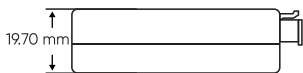

Top View

- 1-Status LED
- 2-Prog. LED
- 3-Prog KEY
- 4-KNX-TP
- 5-Input 1
- 6-Input 2
- 7-COM
- 8-A/C UNIT

Warnings

- Installation, electrical connection, configuration and commissioning of the device can only be carried out by qualified personnel in compliance with the applicable technical standards and laws of the respective countries.
- The electrical connection of the device can only be carried out by qualified personnel. The incorrect installation may result in electric shock or fire. Before making the electrical connections, make sure the power supply has been turned off.
- Do not connect the main voltage (230V AC) to digital input and KNX connector of the device.
- Opening the housing of the device causes the immediate end of warranty period.
- In case of tampering, the compliance with the essential requirements of the applicable directives, for which the device has been certified, is no longer guaranteed.



Check compatibility list before installation

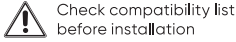

CONNECTION

The device comes with a cable for direct connection to the related terminals of the Air Conditioner Indoor Unit.

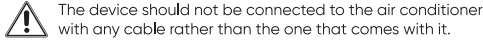

CONNECTION TO THE INDOOR UNIT

- Disconnect the main power from the AC unit.
- Open the internal controller board.
- Find the CN-REMO terminals
- Connect the white connector on the installation cable supplied with the device to the CN-REMO connector on the air conditioner, and the black connector to the A/C Unit connector of the device.

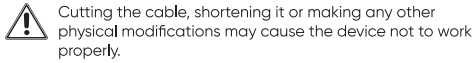

CONNECTION TO THE KNX BUS

- Disconnect power of the KNX bus.
- Connect to the KNX TP-1 (EIB) Bus Line using the device's standard KNX connector (red/black), respect polarity.
- Reconnect power of the KNX bus.

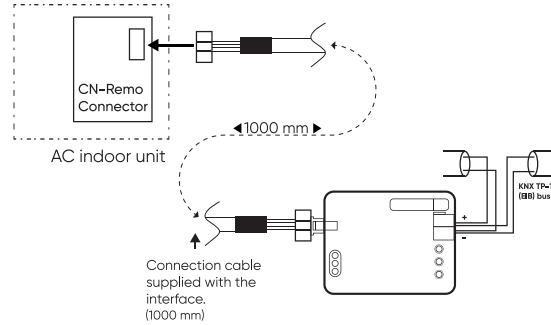
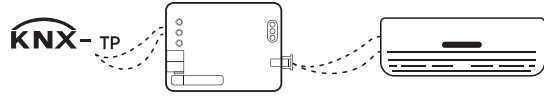

Commissioning

• Configuration and commissioning of the device require the use of the ETS4 or later releases. These activities must be carried out according to the design of the building automation system done by a qualified planner.

• For the configuration of the device parameters the corresponding application program or the whole Core product database must be loaded in the ETS program. For detailed information on configuration options, refer to the application manual of the device available on the website www.core.com.tr

• For commissioning the device the following activities are required

- make the electrical connections as described above,
- turn on the bus power supply,
- switch the device operation to the programming mode
- download into the device the physical address and the configuration with the ETS program.

• At the end of the download the operation of the device returns to normal mode

• Now the bus device is programmed and ready to use

Core Bina Otomasyon Sistemleri Ltd. Şti.
Fatih Mahallesi Ege Caddesi No:42/5
Gaziemir - İzmir - Türkiye

Compatibility List Programming Manual

