

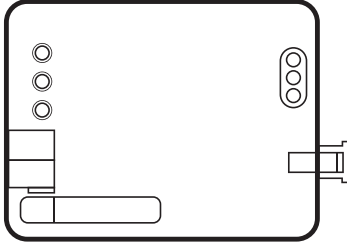

# Quick Start Guide

## SAMSUNG NASA GATEWAY



CR-CG-SMG-KNX-01

### Package Contents

- Core Samsung NASA Gateway
- Connection cable

Core Bina Otomasyon Sistemleri Ltd. Şti.  
Fatih Mahallesi Ege Caddesi No:42/5  
Gazimir - İzmir - Türkiye

Compatibility List    Programming Manual



www.core.com.tr



CONCEPT	DESCRIPTION
Type of Device:	Core Samsung NASA KNX Gateway
Power Consumption:	10mA Max.
Complementary Mode:	S-Mode, System-B
Dimensions:	68.50mm X 4900mm X 19.70mm
Response on AC Unit Faults / Disconnect:	LED2 Red Flashes (500ms On, 500ms Off)
Number of Inputs:	2 Digital Inputs
Input Switching Type:	Dry Voltage Contacts between Input and Common
Input Cable Cross-Section:	0.5-1mm <sup>2</sup> (IEC) / 26-16AWG(UL)
Connection Cable Length:	1m approx
Connection Cable Specification:	4x0.34mm(29AWG) with Screen for reduced interference
Connection @ AC Unit Equipment Side:	F3, F4
Certification:	KNX Certified
Configuration:	Configuration with ETS

## Components



## Safety Remarks

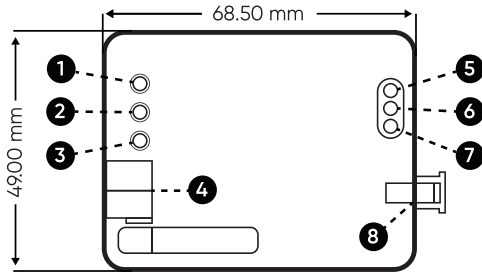

Front View

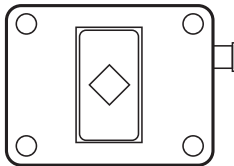

Rear View

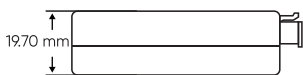

Top View

- 1-Status LED
- 2-Prog. LED
- 3-Prog KEY
- 4-KNX-TP
- 5-Input 1
- 6-Input 2
- 7-COM
- 8-A/C UNIT

### Warnings

- Installation, electrical connection, configuration and commissioning of the device can only be carried out by qualified personnel in compliance with the applicable technical standards and laws of the respective countries.
- The electrical connection of the device can only be carried out by qualified personnel. The incorrect installation may result in electric shock or fire. Before making the electrical connections, make sure the power supply has been turned off.
- Do not connect the main voltage (230V AC) to digital input and KNX connector of the device.
- Opening the housing of the device causes the immediate end of warranty period.
- In case of tampering, the compliance with the essential requirements of the applicable directives, for which the device has been certified, is no longer guaranteed.



Check compatibility list before installation

 Check compatibility list before installation

### CONNECTION

The device comes with a cable for direct connection to the related terminals of the Air Conditioner Indoor Unit.

 The device should not be connected to the air conditioner with any cable rather than the one that comes with it.

### CONNECTION TO THE INDOOR UNIT

- Disconnect the main power from the AC unit.
- Open the internal controller board.
- Find the F3, F4 terminals
- Connect Yellow and Green cables on the installation cable supplied with the device to F3 and F4 terminals on the air conditioner (cables can be connected in any direction due to no polarity), and the black connector to the A/C Unit connector of the device

 Cutting the cable, shortening it or making any other physical modifications may cause the device not to work properly.

### CONNECTION TO THE KNX BUS

- Disconnect power of the KNX bus.
- Connect to the KNX TP-1 (EIB) Bus Line using the device's standard KNX connector (red/black), respect polarity.
- Reconnect power of the KNX bus.

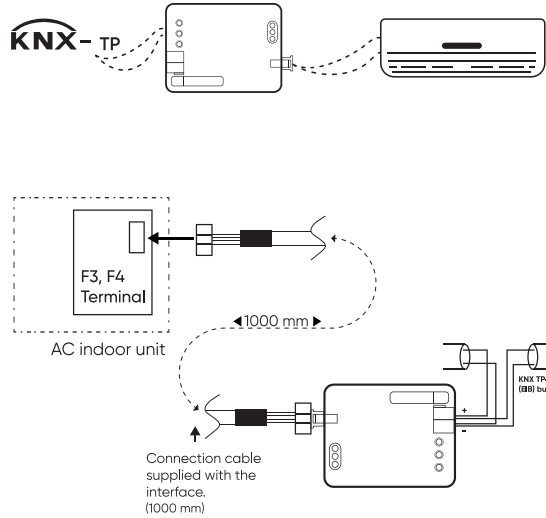

## Commissioning

• Configuration and commissioning of the device require the use of the ETS4 or later releases. These activities must be carried out according to the design of the building automation system done by a qualified planner.

• For the configuration of the device parameters the corresponding application program or the whole Core product database must be loaded in the ETS program. For detailed information on configuration options, refer to the application manual of the device available on the website [www.core.com.tr](http://www.core.com.tr)

• For commissioning the device the following activities are required

- make the electrical connections as described above,
- turn on the bus power supply,
- switch the device operation to the programming mode
- download into the device the physical address and the configuration with the ETS program.

• At the end of the download the operation of the device returns to normal mode

• Now the bus device is programmed and ready to use

Core Bina Otomasyon Sistemleri Ltd. Şti.  
Fatih Mahallesi Ege Caddesi No:42/5  
Gaziemir - İzmir - Türkiye

Compatibility List  
Programming Manual

